



Flow Monitor

Instruction Manual



FLOW MONITOR (THIRD EDITION REV 1)

January 2021

Part Number M-560-A-002-5P

COPYRIGHT

© Pulsar Measurement, 2017 - 21. All rights reserved. No part of this publication may be reproduced, transmitted, transcribed, stored in a retrieval system, or translated into any language in any form without the written permission of Pulsar Process Measurement Limited.

WARRANTY AND LIABILITY

Pulsar Process Measurement Limited guarantee for a period of 2 years from the date of delivery that it will either exchange or repair any part of this product returned to Pulsar Process Measurement Limited if it is found to be defective in material or workmanship, subject to the defect not being due to unfair wear and tear, misuse, modification or alteration, accident, misapplication, or negligence.

DISCLAIMER

Pulsar Measurement neither gives nor implies any process guarantee for this product and shall have no liability in respect of any loss, injury or damage whatsoever arising out of the application or use of any product or circuit described herein.

Every effort has been made to ensure accuracy of this documentation, but Pulsar Measurement cannot be held liable for any errors.

Pulsar Measurement operates a policy of constant development and improvement and reserves the right to amend technical details, as necessary.

The Flow Monitor shown on the cover of this manual is used for illustrative purposes only and may not be representative of the actual Flow Monitor supplied.

CONTACT

For technical support, please contact:

Europe: supporteurope@pulsarmeasurement.com

Outside Europe: supportnorthamerica@pulsarmeasurement.com

If you have any comments or suggestions about this product, please contact:

Europe: europe@pulsarmeasurement.com

Outside Europe: northamerica@pulsarmeasurement.com

Pulsar Measurement website: www.pulsarmeasurement.com

United States
11451 Belcher Road South
Largo,
FL 33773
888-473-9546

Canada
16456 Sixsmith Drive
Long Sault, Ont.
K0C 1P0
855-300-9151

United Kingdom
Cardinal Building, Enigma
Commercial Centre
Sandy's Road, Malvern
WR14 1JJ
00 44 (0)1684 891371

CONTENTS

Chapter 1: Start Here.....	7
About this Manual	7
About the Flow Monitor	8
Product Specification.....	9
EU Declaration of Conformity	10
Chapter 2 Installation.....	11
Unpacking	11
Power Supply Requirements.....	11
Location	11
Dimensions	12
Terminal Connection Detail	14
Terminal Connection Detail	15
AC and Fuse Location.....	16
Preparation for Operation	16
Maintenance	16
Chapter 3 How To Use Your FlowMonitor.....	17
Operating the Controls.....	18
Hot Keys.....	19
Menu Keys	20
Numeric Keys.....	20
Run Mode.....	21
LED's.....	21
Program Mode.....	22
How to Access Program Mode.....	22
Directly Editing Parameters.....	23
Test Mode	24
Using the RS232 Serial Interface.....	25
Parameter Defaults.....	25
Chapter 4 Parameter Guide.....	26
Menu System Diagrams	26

Application Menu.....	27
Relays Menu.....	28
Display Menu.....	29
mA Output Menu.....	30
Totaliser Menu.....	30
System Menu.....	31
Test Menu.....	32
Application Parameters.....	33
Operation.....	33
Device Comms.....	35
Relay Parameters.....	37
Relay Type.....	37
Alarms.....	38
Control.....	41
Totaliser.....	42
Common Parameters.....	42
Display Parameters.....	43
Options.....	43
Failsafe.....	44
Auxiliary.....	45
mA Output Parameters.....	46
Range.....	46
Operation.....	46
Setpoint.....	47
Limits.....	47
Trim.....	48
Failsafe.....	48
Totaliser Parameters.....	49
Setup.....	49

FLOWMONITOR INSTRUCTION MANUAL

Totalisers.....	50
Tot. Audit.....	50
System Parameters	51
Passcode	51
System Information	51
Date & Time	52
Daylight Saving Time.....	52
Test Parameters	56
Simulation	56
Hardware	57
Chapter 5 Troubleshooting.....	58
Chapter 6 Disposal	59

CHAPTER 1: START HERE...

Congratulations on your purchase of Pulsar's Flow Monitor system. This quality system has been developed over many years and represents the latest in high technology ultrasonic level measurement and control.

It has been designed to give you years of trouble-free performance, and a few minutes spent reading this operating manual will ensure that your installation is as simple as possible.

About this Manual

It is important that this manual is referred to for correct installation and operation. There are various parts of the manual that offer additional help or information as shown.

Tips



TIP: Look for this icon throughout your Pulsar Measurement manual to find helpful information and answers to frequently asked questions.

Additional Information

Additional Information

At various parts of the manual, you will find sections like this that explain specific things in more detail.

About the Flow Monitor

The Pulsar Flow Monitor has been designed to provide a simple interface to the Pulsar Flow Pulse Sensor.

Housed in an IP67 enclosure the product is ideally suited to applications where velocity monitoring, reporting or control is required.

The controller is very easy to use and may be quickly and simply setup via the on-board keypad and display.

The Flow Monitor is designed to provide you with highly reliable measurement in a robust and functional package that is easy to use and low in cost.



Product Specification

PHYSICAL

Wall Mount

Outside dimensions 130 x 150 x 63.5 mm

Weight Nominal 0.65 kg

Enclosure material/description ABS base with Polycarbonate lid, flammability rating UL94HB

Cable entry detail underside fitted with 3 x M20, nylon cable glands suitable for 6 – 12mm cable

ENVIRONMENTAL

IP Rating (Wall) IP66/67

Max. & min. temperature (electronics) -20 °C to +50 °C

CE Approval See EU Declaration of Conformity

OUTPUTS

Analogue output Isolated active output (passive output optional) of 4-20 mA or 0-20 mA into 1K Ω (user programmable and adjustable) 0.1% resolution

Display 2 x 12 alpha numeric

Serial Port RS232 for programming and data extraction

Volt free contacts, number, and rating 5 form "C" (SPDT) rated at 5A at 115V/240V AC

PROGRAMMING

On-board programming By integral keypad

Programming security Via passcode (user selectable and adjustable)

Programmed data integrity Via non-volatile RAM

SUPPLY

Power Supply 85 – 264V ac 50/60 Hz,
DC 22 - 28V
10W maximum power (typically 8W)

Mains Fuse 2A T" 20mm

DC Fuse Self-resetting Type

Pulsar Measurement Limited operates a policy of constant development and improvement and reserve the right to amend technical details, as necessary.

EU Declaration of Conformity



EU DECLARATION OF CONFORMITY

P U L S A R *Flow Monitor*

This declaration of conformity is issued under the sole responsibility of the manufacturer

Relevant Directive(s)	2014/30/EU - EMC Directive and its amending directives. 2014/35/EU - Low Voltage Directive and its amending directives. 2011/65/EU - RoHS Directive and its amending directives.
Manufacturer's Name	Pulsar Process Measurement Ltd.
Manufacturer's Address	Cardinal Building, Enigma Business Commercial Centre, Sandy's Road, Malvern, Worcestershire, WR14 1JJ, UK.
Apparatus	Pulsar Flow Monitor.
Standards Applied	EN 61010-1:2010+A1:2019 Safety requirements for electrical equipment for measurement, control, and laboratory use. EN 61326-1:2013 EMC, equipment class industrial.

Signed  Name: Dr. Andrew Foo Pulsar Process Measurement Ltd	Date: 18/2/2021 Rev 2.1
---	----------------------------

CHAPTER 2 INSTALLATION

Unpacking

Important Notice

All shipping cartons should be opened carefully. When using a box cutter, do not plunge the blade deeply into the box, as it could potentially cut or scratch equipment components. Carefully remove equipment from each carton, checking it against the packing list before discarding any packing material. If there is any shortage or obvious shipping damage to the equipment, report it immediately to Pulsar Measurement.

Power Supply Requirements

The Flow Monitor can operate from AC supply or from a DC battery. The AC is 85 – 264V, 50/60Hz. The DC is 22 - 28V. In all cases the Flow Monitor will typically consume 8W of power, with a maximum of 10W.

Location

All electronic products are susceptible to electrostatic shock, so follow proper grounding procedures during installation.

The Flow Monitor must be mounted in a non-hazardous (safe) Area.

When choosing a location to mount the enclosure, bear in mind the following:

- Easy access to the enclosure is maintained.
- The mounting surface is vibration-free.
- The ambient temperature is between -20°C and 50°C.
- There should be no high voltage cables or inverters close by.

Dimensions

The dimensions of the mounting holes are as shown below:

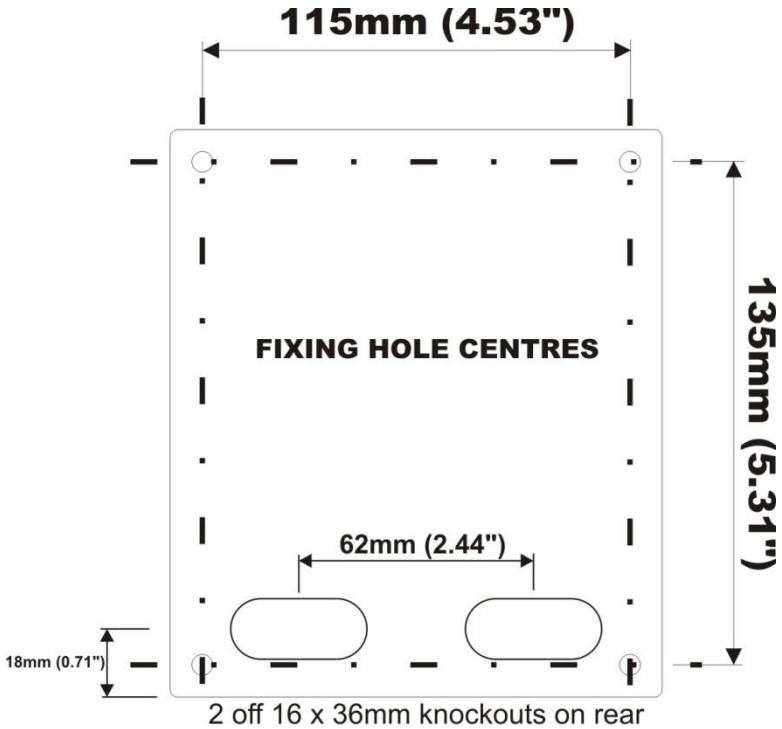

The Flow Monitor should be mounted by drilling four holes suitable for size 8 screws (length and type to suit your application) And fix all four screws by removing the top cover to access the pre-moulded mounting holes which are located in the base of the enclosure under the lid retaining screws.

The full dimensions of the enclosure are as shown below.

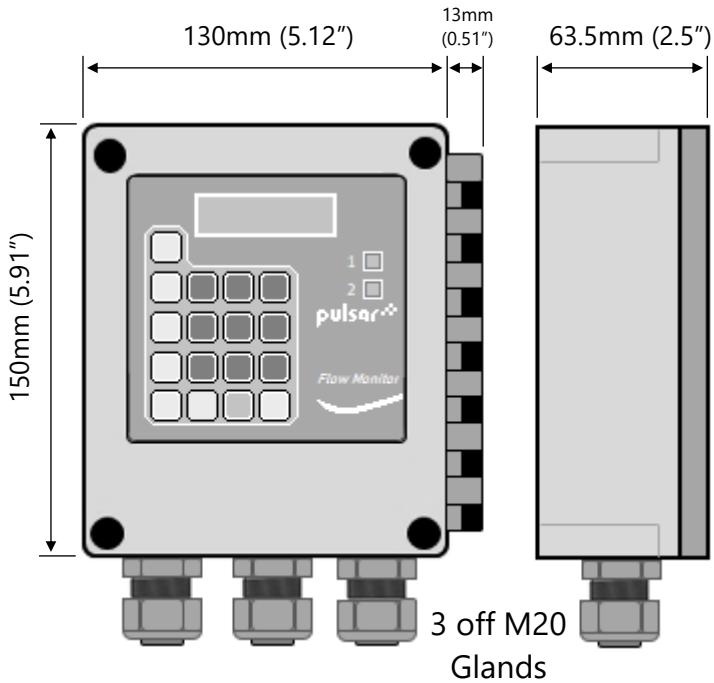

Cable Entry

There are 3 x M20 cable glands, suitable for 6 – 12mm cables, fitted to the base of the Flow Monitor enclosure.

Important Notice

All cable glands should be tightened to the manufacturer's specifications.
 The terminal compartment cover screws should be tightened to 0.5Nm
 Care should be taken not to over tighten the screws.

Terminal Connection Detail

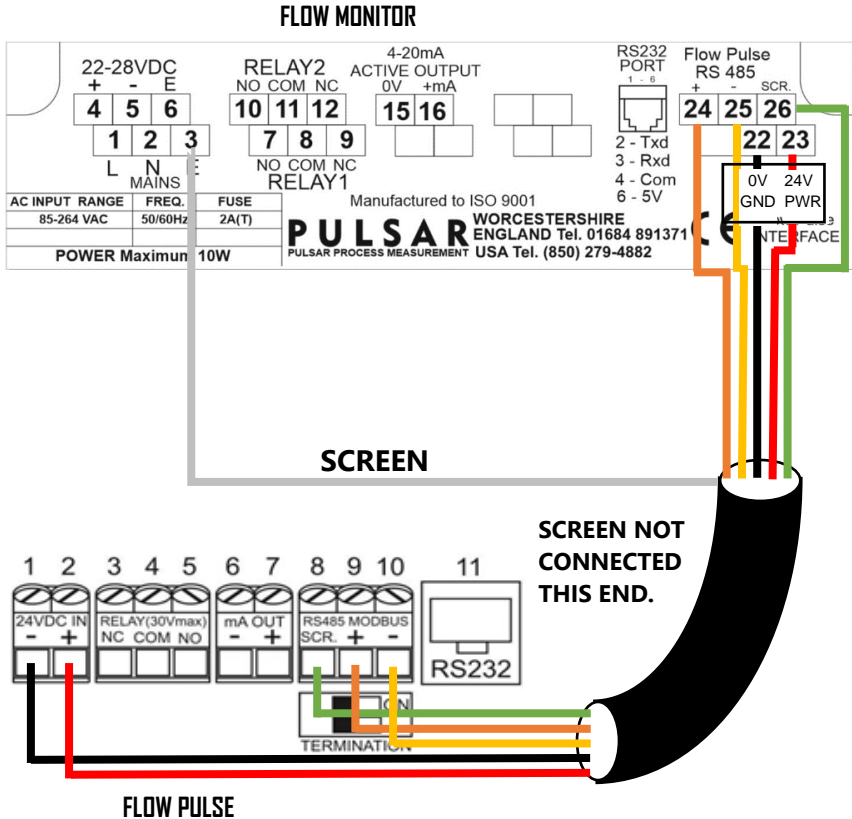

TERMINAL NAME	FLOWMONITOR TERMINAL	FLOWMPULSE TERMINAL
0V (GND)	22	1
24V DC	23	2
*RS485 SCR	26	8
RS485 +	24	9
RS485 -	25	10
Cable Screen	3 or 6	Not Connected

*On older versions of the device, the RS485 screen is connected to terminal 21 (not shown on the above diagram).

Terminal Connection Detail

Power

The Flow Monitor can be powered from mains AC or from a DC source/battery and where a backup DC power source is connected it will automatically take over in the event of AC power failure; DC will automatically power the unit. When AC returns it will switch back.

FlowPulse Sensor

The FlowPulse sensor should be installed and connected, in accordance with the FlowPulse manual.

Wire the FlowPulse sensor to the Flow Monitor sensor terminals, as on the previous page.

Relay Outputs

The two relays can be programmed to a variety of alarm & control functions. The relay contacts are all rated at 2A at 240V AC. All connections should be such that the short circuit capacity of the circuit to which they are connected, is limited by fuses rated so that they do not exceed the relay rating.

Current Output

This is an isolated active mA output of 4 - 20mA or 0 - 20mA, with an option of a passive mA output. The load should not exceed 1K Ω .

RS485 termination switch

By default, this is switched off, to enable RS485 termination both switches need to be switched to the ON position.

Important Notice

If the equipment is installed or used in a manner not specified in this manual, then the protection provided by the equipment may be impaired.

AC and Fuse Location

AC mains power fuse is located, on bottom board to the left and above of the power input terminals, as previously illustrated in the Terminal Connections Detail drawing.

Important Notice

If the equipment is installed or used in a manner not specified in this manual, then the protection provided by the equipment may be impaired.

Preparation for Operation

Before switching on, check the following:

- ✓ The Flow Monitor is mounted correctly and is in a 'safe' area.
- ✓ The power supply is correctly installed.
- ✓ The relays are connected correctly.

Maintenance

There are no user serviceable parts inside your Flow Monitor, except the mains power fuse. If you experience any problems with the unit, then please contact your local Pulsar Measurement distributor for advice.

To clean the equipment, wipe with a damp cloth. Do not use any solvents on the enclosure.

CHAPTER 3 HOW TO USE YOUR FLOWMONITOR

Your Flow Monitor can be programmed directly via the integral keypad.



Operating the Controls

Display

Whilst in the Run Mode it will display the current flow or velocity reading and its units of measurement, along with the mA output and status messages with regards to the communication status and Fail Safe Mode.

When in Program mode, the display is used to read information on the menu system, the parameter number and parameter details and values, which can be entered.

During Test Mode the display is used to monitor the simulated flow or velocity and mA output.



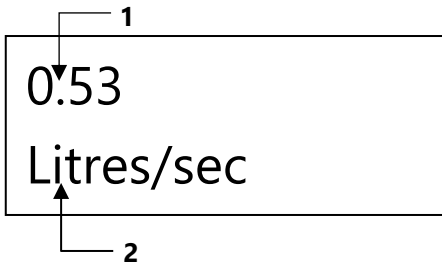



- 1) **Main Display**, 12-digit alpha numeric display:
Run Mode: current measurement displayed, dependent on measurement unit's chosen, and value of Hot Key function selected.
Program Mode: displays parameter number and values entered for parameters.
Test Mode: displays simulated flow or velocity.



- 2) **Auxiliary Display**, scrolling 12-digit alpha numeric display
Run Mode: displays units, totaliser or status messages on communications, detail of Hot Key function selected.
Program Mode: displays Menu and Sub Menu headings, parameter details and options.





Hot Keys

There are five hot keys on the keypad, which can be used to quickly access common parameters for viewing only, while in Run Mode. Pressing the hot key once will display the first parameter, then repeated pressing will display the others, then the Flow Monitor reverts to Run Mode. In program mode, they have different functions, the functions are shown below.

HOT KEY	RUN MODE	PROGRAM MODE
	System totaliser and resettable totaliser	Not used with the Flow Monitor
	Confidence level and signal strength	Not used with FlowCERT
	Not used with Flow Monitor	Reset parameter to default setting
	Instantaneous mA output	Not used with Flow Monitor
	Displays flow and velocity readings	Not used with Flow Monitor
	Not used with Flow Monitor	Takes you to the last parameter edited when you first enter program mode.
	Shows details of function type, firmware revision and serial number	Enter decimal point.

Menu Keys

The menu keys have the following functions:

Hot Key	function
	1) Arrow keys for moving left and right around the menu system.
	2) Used in test mode to simulate the level moving up and down.
	Used to confirm each action (e.g. select a menu option or answer a question asked by the Flow Monitor) or when entering a parameter value.
	Used to navigate up a level in the menu system, and back to run mode. Used to cancel a value entered in error.

Numeric Keys

These keys are used for entering numerical information during programming.

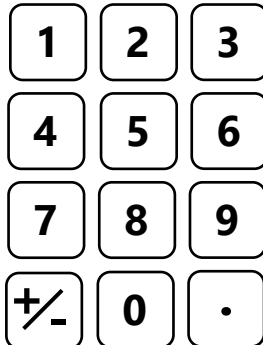

There are two main operating modes for your Flow Monitor, **Run Mode** and **Program Mode**. There is also a **Test Mode**, used for checking the set-up. All modes are now described.

Run Mode

This mode is used once the Flow Monitor has been set up in program mode. It is also the default mode that the unit reverts to when it resumes operation after a power failure.

When the Flow Monitor is switched on for the first time, it will attempt to initiate the FlowPulse sensor and will display a message similar to "Update...." and follow by parameter number. All relays by default are switched off and once the FlowPulse is initialised, the display will show the current flow or velocity and the measurement unit.

After programming is complete, any relays that are set will operate when the measurement reaches the relevant setpoint.

Important Notice

If the FlowPulse sensor is not detected, the *Flow Monitor* will automatically retry to connect to it.

LED's

There are two LED's that can be seen through the lid of the Flow Monitor enclosure, which will indicate the operational **status** of the **relays** whilst in **RUN** mode, as follows:

LED 1	LED 2	RUN MODE
Off	Off	Relays are in their OFF state
Constant On	Off	Relay 1 is in its ON state
Off	Constant On	Relay 2 is in its OFF state
Flash	Off	No sensor is detected
Off	Flash	System error (clock or EEPROM error)

Program Mode

This mode is used to set up the Flow Monitor or change information already set. You must use either the on-board keypad (standard) or alternatively the unit can be set up with a Handheld Calibrator (optional), which must be connected to the Flow Monitor via the RS 232 Serial Interface.

Entering a value for each of the parameters that are relevant to your application provides all the programming information.

How to Access Program Mode

To enter **program mode**, you simply enter the passcode, via the keypad, followed by the ENTER key. The **default passcode** is **1997**, so you would press the following:



Important Notice

There is a time-out period of 15 minutes when in program mode, after which time run mode will be resumed if you do not press any keys.

There are two means of editing parameters, directly or using the menu system. Each is now described.

Using the Menu System

The menu system has been designed to make the changing of parameters very simple. There are two levels of menu: **Main Menu** and **Sub Menu**.

On the display there is a line of text that shows the menu system. Pressing the arrow keys scrolls the display between the top-level menu items, (as shown below, starting at Quick Setup).

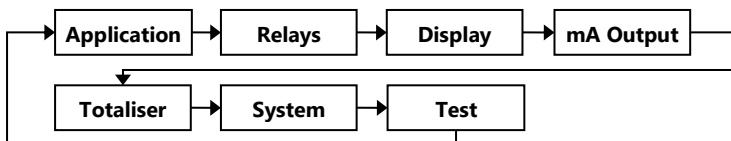

As you press the cursor keys to scroll left and right between these, you can press ENTER at any time to select it and take you to the sub-menu. Each of these options, along with their sub-menus is described in Chapter 5, **Parameter Guide**. When you move down into the sub-menu, you can scroll round using the arrow keys, press ENTER to go to the required section of parameters.

Once you have reached the relevant section, scroll through the parameters, and enter the necessary information. To enter the information, use the numeric keys and press ENTER and you will see the message "**Saved!**". If you press CANCEL, then no change will be made, and the message "**Unchanged!!**" will be displayed.

When you have finished, press CANCEL to go back to the previous level. When you have reached the top level, then the Flow Monitor will ask for confirmation before allowing you to go back into run mode. This is done by pressing ENTER at the display prompt.

Directly Editing Parameters

If you already know the number of the parameter, that you wish to look at or edit, simply type the number in at any time while you are in the menu system. Thus, if you are in either the menu or sub-menu level by pressing a numeric key, you can enter the parameter number directly and jump straight there. You cannot type a parameter number whilst at parameter level, only at one of the two menu levels.

When you are at a parameter, the text line rotates automatically displaying the parameter name, number, the applicable units and the maximum and minimum figure you can enter. The top line shows the value you are setting.

Once you have accessed a parameter, you can either just look at it, or change it.

Once a parameter has been changed, press **ENTER** and you will see the message "**Saved!**". If you press CANCEL, then no change will be made, and the message "**Unchanged!!**" will be displayed.



TIP: You can jump straight to the last parameter you edited, by pressing the +/- key when you first enter program mode.

Test Mode

Test mode is used to simulate the application and confirm that all parameters and relay setpoints have been entered as expected. During simulation, there is a choice of whether the relays will change state (hard simulation) or not (soft simulation), but the LED's will always change state to indicate that the relay setpoints have been activated, and the mA output will change. If you wish to test the logic of the system that the **relays are connected** to then select **hard simulation**, but if you **do not want to change the relay state**, then select a **soft simulation**.

There are two simulation modes, **automatic** and **manual**. **Automatic** simulation will move the velocity up and down between minimum velocity and maximum velocity, whereas **manual** simulation will allow **you** to move the velocity up and down using the arrow keys.

To enter simulation, first go to **program mode**. Then, using the menu system, select menu item '**Test**' then sub-menu item '**Simulation**'. Simply change the value of the parameter **P980** to one of the following:

- 1 = Manual soft simulation
- 2 = Automatic soft simulation
- 3 = Manual hard simulation
- 4 = Automatic hard simulation

To return to program mode, press **CANCEL** and test mode will end.

When in **manual** simulation, by default test mode will move the flow or velocity by 0.25 steps. Altering the **increment (P981)** will change this value.

In **automatic** mode, the rate at which the velocity moves up and down is set by the **increment (P981)**, and the **rate (P982)** in minutes, which can be changed to make the flow or velocity move up and down faster. E.g. if **increment (P981)** is set for 0.25 and **rate (P982)** is set to 1 min then the flow or velocity will increase or decrease at a rate of 0.25/min. To make the simulated flow or velocity move slower, decrease the value in **increment (P981)** or increase the value in **rate (P982)**. To make the simulated flow or velocity move faster, increase the value in **increment (P981)** or decrease the value in **rate (P982)**.

Using the RS232 Serial Interface

The RS232 serial interface is used to program the Flow Monitor and obtain information using a PC or other computer equipment. To do so, the settings for control are as follows: **baud rate 19200, 8 data bits, no parity, 1 stop.**

The device should be connected to the RS232 Interface via the RJ11 connector as shown in **Chapter 2 Installation.**

Parameter Defaults

Factory Defaults

Important Notice

When first installing the Flow Monitor, or subsequently moving or using the unit on a new application, before proceeding to program the unit for its intended application it is recommended that you ensure that all parameters are at their default values by completing a Factory Default (P930).

The **date** (P931) and **time** (P932) in the Flow Monitor were set at the factory, but may need checking or amending if, for example the application is in a time zone other than GMT, see Chapter 5 **Parameter Guide** for full details. Once you are satisfied with the installation, you can proceed with programming for the intended application. It is sensible to program all of the required parameters at the same time. The system will be then set-up.

CHAPTER 4 PARAMETER GUIDE

This chapter describes all of the parameters in your Flow Monitor, in the order they appear in the menu system.

Menu System Diagrams

Shown below is a set of charts to show you how all the various parts can be found using the menu system.

Top Level Menu

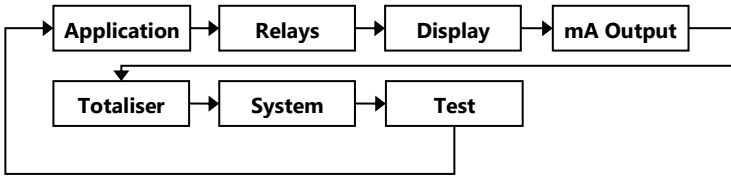

Application Menu

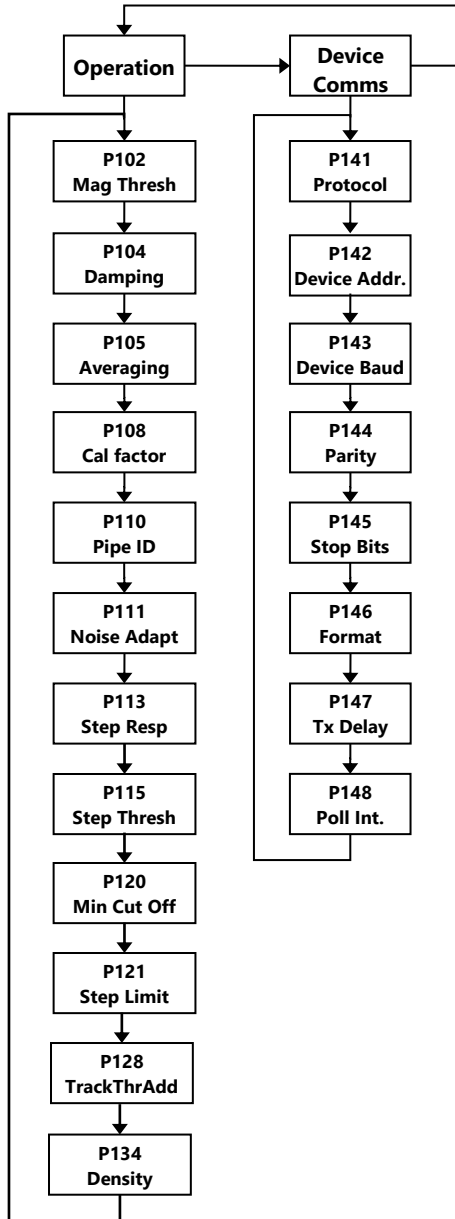

Relays Menu

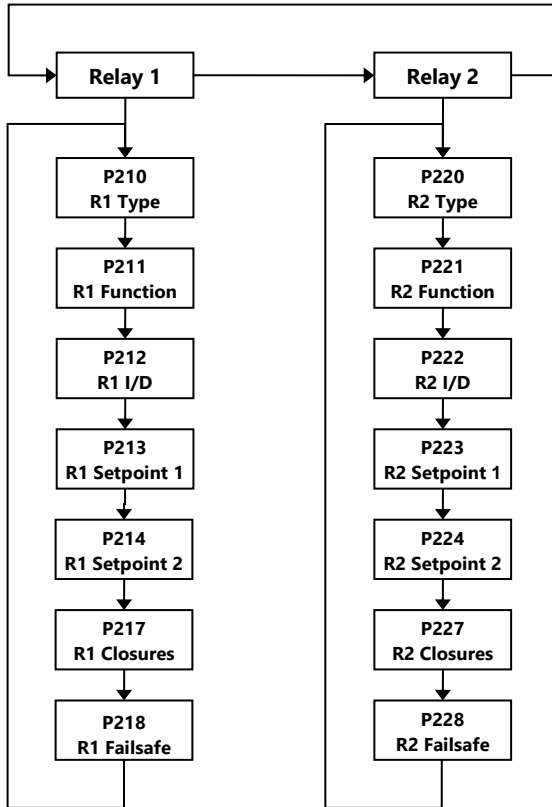

Display Menu

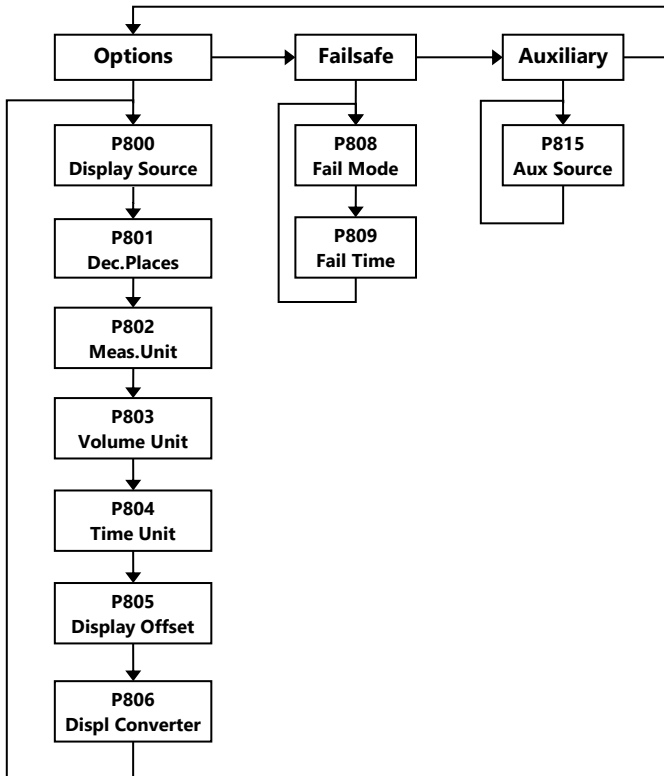

mA Output Menu

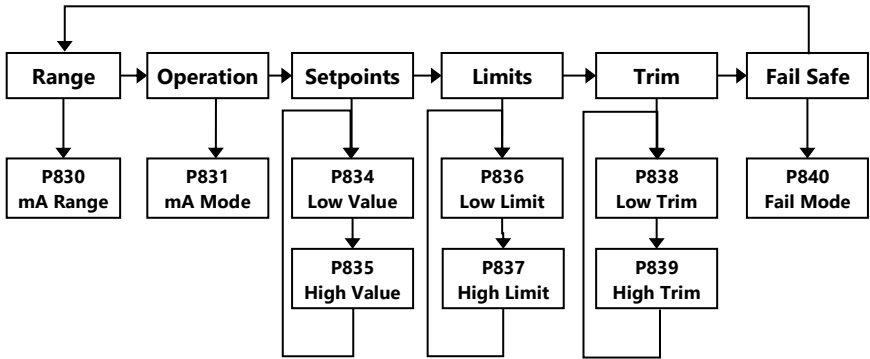

Totaliser Menu

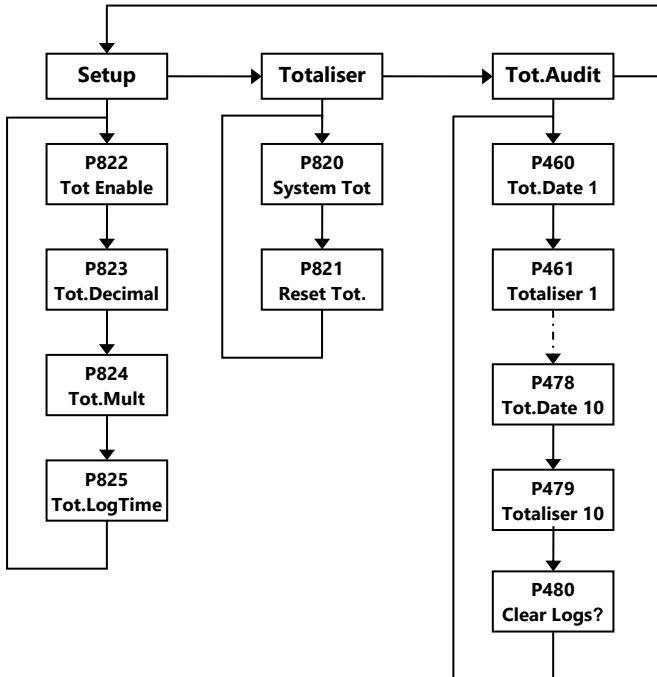

System Menu

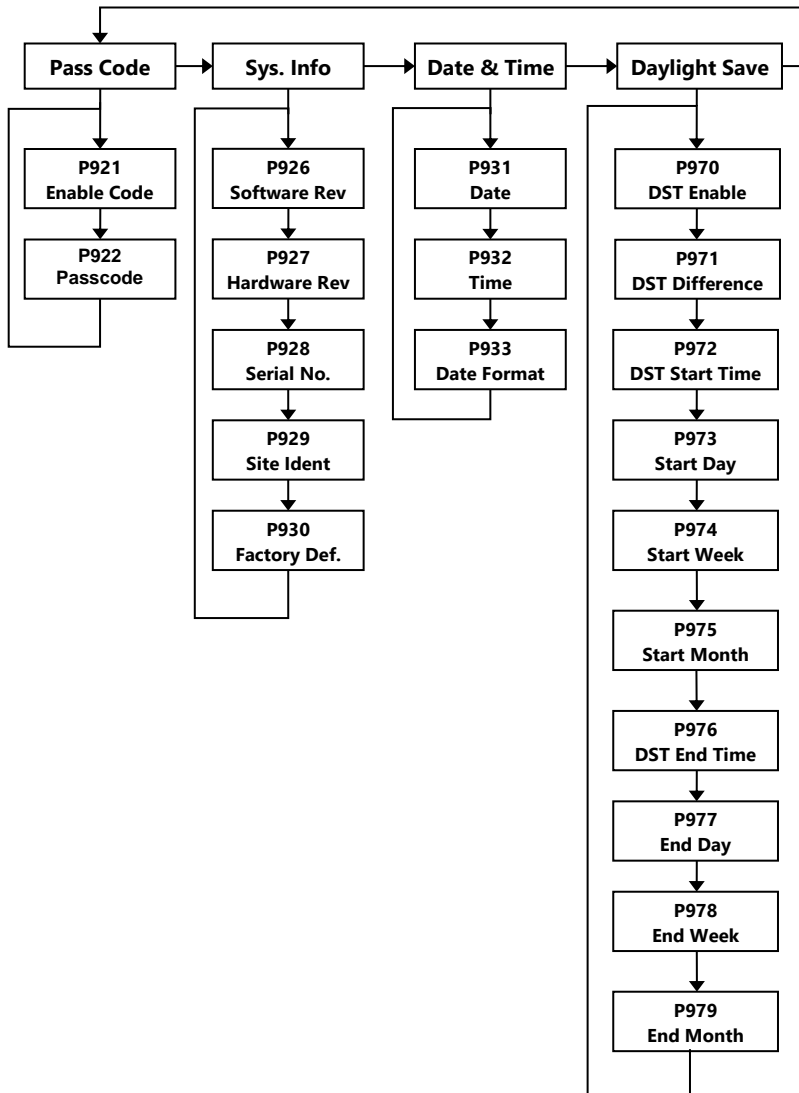

Test Menu

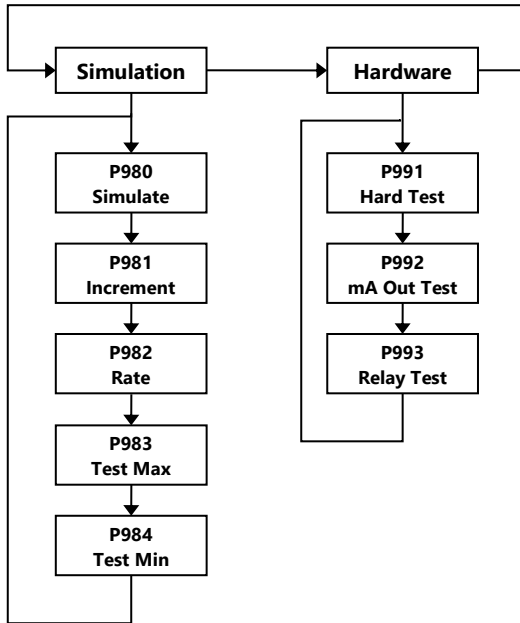

Parameter Listing

This section describes all of the parameters. Any parameter can be reset to its default, by pressing the  hot key, whilst in program mode.

Application Parameters

Operation

P102 Mag Threshold

This parameter sets the sensitivity of FlowPulse sensor. The Mag Threshold value sets the required level of signal above the minimum signal before the FlowPulse decides it is seeing flow. The default is set at 1600 which means that the FlowPulse must see a signal strength of at least 16 above the minimum signal before it decides there is flow.

Default = 1600

P104 Damping

This parameter sets the damping of the FlowPulse unit. The value of the damping sets the amount of flow readings it uses to create an average flow. The default is set to 24, meaning the average of 24 readings will be used as the flow value.

Default = 24

P105 Averaging

This is the number of averaging to perform on the reading – this is independent of the damping process.

Reducing this will increase flow sampling rate at the expense of measurement stability.

Default = 6

P108 Cal Factor

This parameter sets the calibration factor for the FlowPulse unit in percentage. The FlowPulse is designed to give a repeatable flow value. However, if the value being read by the FlowPulse does not meet the flow value that is expected the Cal Factor can be used to modify the output.

Default = 100%

P110 Pipe Diameter

This parameter sets the internal pipe diameter of the pipe that the FlowPulse is connected to.

Default = 0.1 metre

P111 Noise Adapt Threshold

This parameter defines the difference between the minimum value of the trace and the normal floor before a trace is considered to have a raised noise floor due to noise.

Default = 800

P113 Step Response

The step response allows Flow Pulse to temporarily bypass damping and track any sudden change in flow commonly encountered during the beginning and end of a pumping cycles.

OPTION	DESCRIPTION
0 = Off	No Effect
1 = On (Default)	Step Response is enabled

P115 StepResThres

The Step Response Threshold is the change in flow required for the normal damping to be bypassed. The range of the step response threshold is:

Min = 22, Max = 426 **Default = 60**

426 relates to the 'Flow High' value.

The higher the step response threshold, the larger the jump in flow needs to be before damping is skipped.

P120 Minimum Flow Cut-off

This parameter multiplies the units of flow by 23 on the horizontal axis of the flow trace. E.g. if the parameter is set to 2300, then the corresponding flow index would be 100. The Flow Pulse via the Flow Monitor will not report any flow unless the flow indicator exceeds 100 on the flow index.

Default = 740

P121 Step Limit

This parameter sets the limit on any sudden change in the flow reading between measurements, even while damping is being bypassed by step response.

P128 TrackThrAdd

This is only activated when noise floor is raised, such that the noise floor is more than P111 away from the normal floor without flow. This causes the flow to be tracked at a lower flow index so that compensation can be applied.

Min = 20, Max = 2000 **Default = 400**

P134 Particle Density

This parameter is used to set the type of material being measured in the pipe that the FlowPulse is attached to.

OPTION	DESCRIPTION
0 = Very Low	Material has very low particle density
1 = Low	Material has low particle density
2 = Medium (Default)	Material has medium particle density
3 = High	Material has high particle density
4 = Very High	Material has very high particle density

Device Comms

P141 Protocol

This parameter determines the communication protocol that the processor uses to initialise the FlowPulse sensor.

OPTION	DESCRIPTION
0 = Modbus RTU (Default)	Modbus RTU with hexadecimal data
1 = Modbus ASCII	Modbus ASCII with ASCII data

P146 Extended Format

This parameter determines the data format that the processor uses to communicate with the FlowPulse sensor.

OPTION	DESCRIPTION
0 = Unsigned Integer (Default)	Unsigned Integer data
1 = Signed Integer	Signed Integer data
2 = Float Motorola Format	Motorola floating point format
3 = Float IEEE Format	IEEE 754 floating point format

P147 Tx Delay

This parameter determines the transmission delay that the processor uses to communicate with the FlowPulse sensor.

Default = 5ms

P148 Poll Interval

This parameter determines the polling interval that the processor uses to exchange data with the FlowPulse sensor.

Default = 1.5 seconds

Relay Parameters

All relay related parameters are prefixed with a 2**.

The second digit of the three figure parameter number denotes the relay number as follows:

21* parameters for Relay 1

22* parameters for Relay 2

The third digit selects specific parameters for the setting up of the relays, which can be selected individually and results in the following parameter numbers for each relay.

Relay 1 210 to 218

Relay 2 220 to 228

Relay Type

P210, P220 - Relay Type

This parameter defines what type each relay should be, see the table below or available options.

OPTION	DESCRIPTION
0 = Not In Use (Default)	Relay not in use programmed.
1 = Alarm	Relay is programmed as an alarm relay, which will de-energise ON, and energise OFF. This will ensure an alarm is raised if the power fails to the unit.
2 = Control	Relay is programmed as a control relay, which will energise ON, and de-energise OFF.
3 = Totaliser	Relay is programmed as a totaliser relay, which will energise ON, and de-energise OFF as pulsing relay

Alarms

P210, P220 =1 (Alarm)

The second parameter for each relay determines the function of the alarm.

P211, P221 - Relay Function

This parameter defines what function the alarm will respond to as follows.

OPTION	DESCRIPTION
0 = Off (Default)	Relay will not operate.
1 = Flow	Alarm is based on the flow rate and the type of flow alarm (P212, 222) and two setpoints must be set (P213, 223 & P214, 224). Setpoints are entered in Display Units
2 = Velocity	Alarm is based on the velocity, and the type of velocity alarm (P212, 222) and two setpoints must be set (P213, 223 & P214, 224).
3 = Loss of Echo	Alarm is raised if the Failsafe Timer (P809) expires. No setpoints are required.
4 = Loss of Clock	Alarm is raised if the real time clock fails. No setpoints are required.

Note that the loss of echo and loss of clock will also be shown on the display as "NO SENSOR" and "LOST CLOCK" respectively.

The **third parameter** for each relay determines the alarm ID for the relay you wish to set.

P212, 222 - Relay Alarm ID

When P211, P221 = 3 (Loss of Echo) or 4 (Loss of Clock)

This parameter has no function and will not be displayed

When P211, P221 = 1 or 2

This parameter defines which alarm type, the relay should respond to, as follows:

OPTION	DESCRIPTION	SETPOINTS
1 = General (Default)	Relay goes "ON" when the value reaches the ON setpoint and goes "OFF" when the value reaches the OFF setpoint.	P213, 223 is ON Setpoint. P214, 224 is OFF Setpoint
2 = High	Relay goes "ON" when the value rises to the ON setpoint and goes "OFF" when the value lowers to the OFF setpoint.	ON > OFF Relay Setpoints P213, 223 and P214, 224 Setpoints, can be set in any order as the unit 'knows' that you are setting a high-level alarm.
3 = Hi-Hi	Same as 2 = High, but different identifier.	
4 = Low	Relay goes "ON" when the value lowers to the ON setpoint and goes "OFF" when the value rises to the OFF setpoint.	ON < OFF Relay Setpoints P213, 223 and P214, 224. Setpoints, can be set in any order as the unit 'knows' that you are setting a low level alarm.
5 = LoLo	Same as 4 = Low, but different identifier.	
6 = In bounds	Relay goes "ON" if value is inside the zone between the two setpoints.	Relay Setpoints, P213, 223 and P214, 224 can be set in any order as the unit 'knows' that you are setting an inbounds alarm.
7 = Out of bounds	Relay goes "ON" if value is outside the zone between the two setpoints.	Relay Setpoints P213, 223 and P214, 224 can be set in any order as the unit 'knows' that you are setting an out of bounds alarm.

The **fourth parameter** and the **fifth parameter** for each relay set the Alarm "ON" and "OFF" points. For a **high alarm**, the "ON" is set higher than "OFF". For **low alarm** then "ON" is set lower than "OFF". See the appropriate **alarm ID**, table (P212, 222) for further information.

When P211, P221 = 3 (Loss of Echo) or 4 (Loss of Clock)

This parameter has no function and will not be displayed.

When P211, P221 = 1 or 2

P213, P223 - Relay Setpoint 1

Determines the "ON" or "OFF" point for the alarm according to the ID selected.

P214, P224 - Relay Setpoint 2

Determines the "ON" or "OFF" point for the alarm according to the ID selected.

Important Notice

Setpoints are entered in values according to the function selected.

Flow/Velocity - entered in Display Units.

See the appropriate alarm function, table (P211, 221, 231) for further information.

Control

P210, P220 = 2 (Control)

When a relay is being set up as a **control** relay, the **second parameter** that will be displayed in the menu determines its **function**.

P211, P221 - Relay Function,

This function is used, where it is required to **energise** the relay to switch a device, such as a pump, **ON** and **de-energise** the relay to switch the device **OFF**.

OPTION	DESCRIPTION
0 = Off	Relay is always de-energised
1 = Flow	Relay will energise "ON" as set in Relay Setpoint 1 (P213, 223). And turns " OFF ", de-energises , as set in Relay Setpoint 2 (P214, 224).
2 = Velocity	Relay will energise "ON" as set in Relay Setpoint 1 (P213, 223). And turns " OFF ", de-energises , as set in Relay Setpoint 2 (P214, 224).

Important Notice

A control relay is started and stopped at the "ON" and "OFF" setpoints. To *control down* (reduce level) then set "ON" higher than "OFF". To *control up* (increase level) then set "ON" lower than "OFF". For relay 1 "ON" is P213, "OFF" is P214 and for relay 2 "ON" is P223, "OFF" is P224s

The fourth parameter, and fifth parameter, are set to determine the switch points, "ON" and "OFF" for the relay. See control function, table (P211, 221, 231) for further information.

P213, P223 - Relay Setpoint 1

This parameter determines the "ON" point for the control relay. Relay Setpoints are entered in values of Measurement Units (P802).

P214, P224 - Relay Setpoint 2

This parameter determines the "OFF" point for the control relay. Relay Setpoints are entered in values of Measurement Units (P802).

Totaliser

P210, P220 = 3 (Totaliser)

When a relay is set up as a totaliser relay, the second and third parameters that will be displayed in the menu determine the frequency and duration of the relay pulse.

P213, P223 - Relay Setpoint 1

The factor by which the on board totaliser (P820) should be multiplied by to provide a relay closure, giving the frequency of the pulse.

Default = 0.00

P214, P224 - Relay Setpoint 2

The time in seconds to set the duration of the relay pulse.

Default = 0.00 secs.

Common Parameters

P217, P227 - Relay Closures

This parameter displays the number of times the relay has activated since the relay has been in use. It can be reset with any value.

P218, P228 - Relay Fail Safe

The unit has a general fail-safe parameter **P808**. However, this can be overridden so that each individual relay has its own independent fail safe mode.

This parameter determines what the relay will do in the event of the **Failsafe Time (P809)** expiring.

OPTION	DESCRIPTION
0 = Default	Relay assumes system default mode P808
1 = Hold	Relay remains in its current state
2 = De-energise	Relay will De-energise
3 = Energise	Relay will Energise

Display Parameters

Options

P800 Display Source

This parameter determines whether the Flow Monitor uses the Flow or the Velocity.

OPTION	DESCRIPTION
1 = Flow (Default)	Display shows flow readings
2 = Velocity	Display shows velocity readings

P801 Decimal Places

This parameter determines the number of decimal places on the reading during run mode.

Minimum = 0 (No decimal places), Maximum 3 = (3 decimal Places).

Default = 2 (2 decimal Places)

P802 Measurement Unit

This parameter determines the measurement units showed on the reading during run mode.

OPTION	DESCRIPTION
1 = metres (Default)	Measurement in metres
2 = cm	Measurement in centimetres
3 = mm	Measurement in millimetres
4 = feet	Measurement in feet
5 = inch	Measurement in inches

P803 Volume Unit

The value of this parameter determines volume unit of flow readings.

OPTION	DESCRIPTION
1 = litres (Default)	Display volume in litres
2 = cubic metre	Display volume in cubic metres
3 = cubic feet	Display volume in cubic feet
4 = UK gallons	Display volume in UK gallons
5 = US gallons	Display volume in US gallons
6 = MUSG	Display volume in million US gallons

P804 Time Unit

The value of this parameter determines the time unit of flow and velocity readings.

P805 Display Offset

The reading is added by the value of this parameter before being displayed.

Default = 0

P806 Display Conversion

The reading is multiplied by the value of this parameter before being displayed.

Default = 1.0

Failsafe

P808 Fail-safe Mode

By default, if a fail-safe condition occurs, then the display and the output are held at their last **known** values until a valid reading is obtained. If required, you can change this so that the unit goes to **high** (max flow/velocity, **P683**), or **low** (min flow/velocity, **P682**) as follows:

Important Notice

In the event of a fail-safe condition occurring, the display and Output can be configured to fail to a condition which is independent of each other. To set independent Output Failsafe see P840.

P809 Fail-safe Time

In the event of a fail-safe condition the failsafe timer determines the time before fail-safe mode is activated. **Default = 2min**

If the timer activates, the unit goes into **fail-safe** as determined by **P808 (Display)** and **P840 (Output)**. When this happens, you will see the message "**Failed Safe!**" on the display, along with a message explaining why (lost comm. or comm. error, for example).

When a valid measurement is obtained then the display and output will be restored, and the timer is reset.

Auxiliary

P815 Aux Source

Determine the display on the secondary line of screen

OPTION	DESCRIPTION
0 = Units (Default)	Display the units of the main display
1 = Flow	Display flow readings
2 = Velocity	Display velocity readings
3 = Totaliser	Display resettable totaliser

mA Output Parameters

Range

P830 Output Range

This parameter determines the range of the mA output, from the following.

OPTION	DESCRIPTION
0 = Off	Output disabled
1 = 0 to 20mA	Output directly proportional to the output mode (P831) , so if the reading is 0% the output is 0 mA. If the reading is 100% the output is 20 mA.
2 = 4 to 20mA (Default)	output directly proportional to the output mode (P831) , so if the reading is 0% the output is 4 mA. If the reading is 100% the output is 20 mA.
3 = 20 to 0mA	output inversely proportional to the output mode (P831) , so if the reading is 0% the output is 20 mA. If the reading is 100% the output is 0 mA.
4 = 20 to 4mA	output inversely proportional to the output mode (P831) , so if the reading is 0% the output is 20 mA. If the reading is 100% the output is 4 mA

Operation

P831 Output Mode

This parameter determines the output mode of the mA output, from the following.

OPTION	DESCRIPTION
0 = Default (Default)	mA output follows P800 (Display Source)
1 = Flow	mA output according to flow reading
2 = Velocity	mA output according to velocity reading

Setpoint

By default, the mA Output will represent the 0% (0 or 4mA dependent on **(P830) Output Range**) and **100%** of the operational **span (20mA)**, but you may wish to have the output represent a section of the operational span. For example, the application has an operational span of 6 m/s but **output** is to **represent 0m/s (0 or 4mA** dependant on **(P830) Output Range**) to a **level of 5 m/s (20mA)**. If so P834 (Low Setpoint) should be set to 0.00 m/s and P835 (High Setpoint) should be set to 5 m/s.

P834 Output Low Level

This parameter sets the measurement value at which the low mA output will occur (**0 or 4mA** dependant on **(P830) Output Range**)

Default = 0 I/s

P835 Output High Level

This parameter sets the measurement value at which the high mA output will occur (**20mA**).

Default = 6000 I/s

Limits

P836 Output Low Limit

This parameter sets the lowest level that the mA output will drop to, the default is 0mA, but you can override this if the device you connect to cannot for example accept less than 2mA, yet you want to use the 0-20mA range.

Default = 0.00mA

P837 Output High Limit

This parameter sets the highest level that the mA output will rise to, the default is 20 mA, but you can override this if the device you connect to cannot for example accept more than 18 mA, yet you want to use the 0-20 mA range. **Default = 20.00mA**

Trim

P838 Output Low Trim

If the device you are connected to is not calibrated, and not showing the correct **low value** (reading), then you can trim it using this parameter. You can either type in the offset directly or use the arrow keys to move the output up and down until you get the expected result (reading) on the device that is connected.

P839 Output High Trim

If the device you are connected to is not calibrated, and not showing the correct **high value** (reading), then you can trim it using this parameter. You can either type in the offset directly or use the arrow keys to move the output up and down until you get the expected result (reading) on the device that is connected.

Failsafe

P840 Output Fail-safe Mode

This parameter determines what happens to the output in the event of the unit going into fail-safe mode. The **default** is to do the same as the **system fail-safe (P808)**, but this can be overridden to force the output to an independent fail-safe mode as follows:

OPTION	DESCRIPTION
0 = Default	Output will fail as per P808
1 = Hold	Output will retain its last known value
2 = Low	Output will fail to its low condition.
3 = High	Output will fail to its high condition (20mA maximum)
4 = Very Low	Output will fail to its lowest or fault condition of 2mA for 4-20 range or 0mA for 0-20 range.
5 = Very High	Output will fail to its highest or fault condition of greater than 20mA (22mA maximum)

Totaliser Parameters

Setup

P822 Totaliser Enable

This parameter determines if the totaliser is enabled or not, options are:

OPTION	DESCRIPTION
0 = No (Default)	Totaliser is disabled
1 = Yes	Totaliser in enabled

P823 Totaliser Decimal

This parameter determines the number of decimal places in the totaliser during run mode. It can be set between 1 and 3. **Default = 2**

P824 Totaliser Multiplier

Use this parameter if the totaliser increments by to large or small amount, enter the factor by which the actual flow rate is multiplied by before incrementing the totaliser.

E.g. if flowrate is being calculated and displayed in litres/second and it is desired to increment the totaliser in cubic metres select 7 = *1000.

When viewing, the totaliser display will state, "Units are: L*1000", and the totaliser will be incremented every 1000 litres

OPTION	DESCRIPTION
1 = 1/1000	Totaliser will increment every 1/1000 th units of flow
2 = 1/100	Totaliser will increment every 1/100 th units of flow
3 = 1/10	Totaliser will increment every 1/10 th units of flow
4 = *1 (Default)	Totaliser will increment every 1 units of flow
5 = *10	Totaliser will increment every 10 units of flow
6 = *100	Totaliser will increment every 100 units of flow
7 = *1,000	Totaliser will increment every 1000 units of flow
8 = *10,000	Totaliser will increment every 10,000 units of flow
9 = *100,000	Totaliser will increment every 100,000 units of flow
10 = *1,000,000	Totaliser will increment every 1,000,000 units of flow
11 = 1/10,000	Totaliser will increment every 1,000,000 units of flow
12 = 1/100,000	Totaliser will increment every 1/100,000 units of flow
13 = 1/1,000,000	Totaliser will increment every 1/1,000,000 units of flow

P825 Totaliser Log Time

This parameter sets the time at which the totalisers are stored in non-volatile memories.

Default = 00:00

Totalisers

P820 System Totaliser

Displays the current value of the, non-resettable totaliser. During run mode this totaliser can be viewed via the "Totaliser" hot key. Unlike the resettable totaliser this totaliser cannot be reset whilst in run mode, it can however be reset whilst in program mode by accessing **P820 Totaliser** and entering **zero**.

P821 Resettable Totaliser

Displays the current value of the, resettable totaliser. This totaliser can be allocated to appear, during run mode, on the auxiliary display line (**P815**) or alternatively via the "Totaliser" hot key.

Tot. Audit

P460 to P479 Totaliser Audits

Parameters **P460-P479** show the **date** and total **flow** for the last **ten days**, the first on the list are the most recent and last ones are the oldest. When all ten total audits are full the oldest is pushed out and all totals increment through to allow the new days total to be registered in the first day's total audit parameter allocation.

P480 Clear Logs

This parameter enables **all** of the Total Audits (P460 - P479) to be cleared to factory default values.

System Parameters

Passcode

P921 Enable Code

Enables the passcode (**P922**), which means the passcode must be entered to go into program mode. If **disabled** (set to **0**), then no passcode is required, and ENTER is used to enter program mode. **Default = 1 (Enabled)**

P922 Passcode

This is the passcode that must be used to enter program mode. The **default** is **1997**, but this can be changed to another value from 0 to 9999.

System Information

The following three parameters do not affect how the unit performs, but details contained within them may be required, by Pulsar, when making technical enquiries.

P926 Software Revision

This parameter will show the current software revision

P927 Hardware Revision

This parameter will show details of the current hardware revision

P928 Serial Number

This parameter will show the serial number of the unit.

P929 Site Identification

This parameter allows you to give each unit an individual reference number, for identification purposes. You can set any number between 1 and 99999.

P930 Factory Defaults

This parameter resets all parameter values to the original Factory Set values that were installed when the unit was tested before despatch to you.

To **reset** parameters, enter **1 (Yes)**, and press **ENTER**, then you will see a message "**Entr if sure**", you should press **ENTER** again. If you press any other key at this point, the parameters will not be reset, and you will see a message confirming this.

Once you have done this, program the unit, to the desired application.

Date & Time

P931 Date

This parameter shows the **current date**, in the format as set by **P933 (Date Format)** and can be reset if required.

P932 Time

This parameter shows the **current time** and can be reset if required, in the format HH: MM (24-hour format). This is set initially at the factory for UK time.

P933 Date Format

This parameter allows you to alter the format that the date is displayed to your choice of DD: MM: YY, MM: DD: YY or YY: MM: DD. The default is DD: MM: YY.

Daylight Saving Time

P970 DST Enable

When Enabled (set to 1) the internal clock will be automatically adjusted to compensate for the difference between standard time and Daylight Saving Time.

OPTION	DESCRIPTION
0 = No	DST is disabled
1 = Yes (Default)	DST in enabled

P971 DST Difference

This parameter sets the time difference between standard time and Daylight Saving Time. The time difference is entered in HH: MM.

Default = 01:00

P972 DST Start Time

This parameter is used to set the time of day at which Daylight Saving Time will **start**, the time is entered in the format HH: MM (24-hour format).

Default = 02:00

P973 Start Day

Use this parameter to enter the day of the week (P974) that Daylight Saving Time is to **start**.

OPTION	DESCRIPTION
2 = Monday	DST will start on a Monday
3 = Tuesday	DST will start on a Tuesday
4 = Wednesday	DST will start on a Wednesday
5 = Thursday	DST will start on a Thursday
6 = Friday	DST will start on a Friday
7 = Saturday	DST will start on a Saturday
8 = Sunday (Default)	DST will start on a Sunday

P974 Start Week

This parameter will determine the week of the month (P975) in which Daylight Saving Time is to **start**.

OPTION	DESCRIPTION
1 = Week 1	DST will start on day (P973) in the first week (P974) of the month (P975).
2 = Week 2	DST will start on day (P973) in the second week (P974) of the month (P975).
3 = Week 3	DST will start on day (P973) in the third week (P974) of the month (P975).
4 = Week 4	DST will start on day (P973) in the fourth week (P974) of the month (P975).
5 = Last (Default)	DST will start on day (P973) in the last week (P974) of the month (P975).

P975 Start Month

This parameter is used to select the month in which Daylight Saving Time is to **start**.

OPTION	DESCRIPTION
1 = January	DST will start during the month of January
2 = February	DST will start during the month of February
3 = March (Default)	DST will start during the month of March
4 = April	DST will start during the month of April
5 = May	DST will start during the month of May
6 = June	DST will start during the month of June
7 = July	DST will start during the month of July
8 = August	DST will start during the month of August
9 = September	DST will start during the month of September
10 = October	DST will start during the month of October
11 = November	DST will start during the month of November
12 = December	DST will start during the month of December

P976 DST End Time

This parameter is used to set the time of day at which Daylight Saving Time will **end**, the time is entered in the format HH: MM (24-hour format).

Default = 02:00

P977 End Day

Use this parameter to enter the day of the week (P978) that Daylight Saving Time is to **end**.

OPTION	DESCRIPTION
2 = Monday	DST will start on a Monday
3 = Tuesday	DST will start on a Tuesday
4 = Wednesday	DST will start on a Wednesday
5 = Thursday	DST will start on a Thursday
6 = Friday	DST will start on a Friday
7 = Saturday	DST will start on a Saturday
8 = Sunday (Default)	DST will start on a Sunday

P978 End Week

This parameter will determine the week of the month (P975) in which Daylight Saving Time is to **end**.

OPTION	DESCRIPTION
1 = Week 1	DST will end on day (P973) in the first week (P974) of the month (P975).
2 = Week 2	DST will end on day (P973) in the second week (P974) of the month (P975).
3 = Week 3	DST will end on day (P973) in the third week (P974) of the month (P975).
4 = Week 4	DST will end on day (P973) in the fourth week (P974) of the month (P975).
5 = Last (Default)	DST will end on day (P973) in the last week (P974) of the month (P975).

P979 End Month

This parameter is used to select the month in which Daylight Saving Time is to **end**.

OPTION	DESCRIPTION
1 = January	DST will start during the month of January
2 = February	DST will start during the month of February
3 = March	DST will start during the month of March
4 = April	DST will start during the month of April
5 = May	DST will start during the month of May
6 = June	DST will start during the month of June
7 = July	DST will start during the month of July
8 = August	DST will start during the month of August
9 = September	DST will start during the month of September
10 = October (Default)	DST will start during the month of October
11 = November	DST will start during the month of November
12 = December	DST will start during the month of December

Test Parameters

Simulation

P980 Simulate

Test mode is used to simulate the application and confirm that all parameters and relay setpoints have been entered as expected. During simulation, there is a choice of whether the relays will change state (hard simulation) or not (soft simulation), but the LED's will always switch according to how the relays have been programmed, and the output will change accordingly. If you want to test the logic of the system that the relays are connected to then select a hard simulation, but if you don't want to change the relay state, then select a soft simulation.

There are two simulation modes, **automatic** and **manual**. Automatic simulation will move the velocity up and down between minimum and maximum velocity and activate the relay and/or corresponding LED at the programmed setpoints, if you wish to change the direction of the velocity movement at any time this can be done by using the arrow keys. In manual simulation, using the arrow keys will allow you to move the velocity up and down as required. The choices for you to enter are as follows.

1. Manual soft simulation
2. Automatic soft simulation
3. Manual hard simulation
4. Automatic hard simulation

To return to program mode, press 'CANCEL' and test mode will end.

P981 Increment

By default, simulation mode will move by **0.25** steps in manual simulation and by 0.25/min in automatic simulation. Altering the increment can change this value.

P982 Rate

In automatic mode, the rate at which the measurement will move up and down is determined by the **Increment (P981)** and the time, **Rate (P982)** which can be changed as required. To increase the rate at which the measurement moves increase the **Increment (P981)** or decrease the **Rate (P982)**. To decrease the rate at which the measurement moves decrease the **Increment (P981)** or increase the **Rate (P982)**.

P983 Test Max

This parameter determines the maximum of the simulated measurement values.

Default = 1000

P984 Test Min

This parameter determines the minimum of the simulated measurement values.

Default = 0

Hardware

P991 Hard Test

When this parameter is selected, the unit will test the following in turn:

- **LED's.** Watch them change colour as shown on the display and press **ENTER** if they operate as shown.
- **Relays.** Press a numeric key, corresponding to the number of the relay you wish to test, and the relay will change state each time the key is pressed. If you press any other key, other than a valid relay number, then the test will end.
- **Segments.** All the segments on the LCD are lit up so you can see if they all work. Press **ENTER** to end the test.
- **Keys.** You should press each key to confirm it works, with a counter showing how many more keys remain un-pressed. Be sure to press the **CANCEL** key last as this will show if all keys were pressed or not. If they were not, then an error message is displayed.

P992 Output Test

This parameter will allow you to force a specified current on to the output to test any equipment that it is connected to. The figure you enter will be generated by the output.

P993 Relay Test

Press a numeric key corresponding to the number of the relay you wish to test, and the relay will change state each time the key is pressed. If you press any other key, other than a valid relay number, then the test will end.

CHAPTER 5 TROUBLESHOOTING

This section describes many common symptoms, with suggestions as to what to do. If the issue persists, please contact your local Pulsar distributor.

SYMPTOM	WHAT TO DO
"No Sensor" message displayed.	Check power supply. Check wiring to FlowPulse sensor.
"P102 Fail" message is displayed	Check that the correct Device Address (Modbus ID) for the FlowPulse has been entered into P142 of the Flow Monitor. This can be checked by connecting the FlowPulse to FlowPulse PC to check the ID set on the sensor.
Current velocity reads zero, but you know there is flow movement.	Ensure FlowPulse sensor is mounted correctly and in accordance with chapter 2.
LED's change colour at relevant relay switch points but relays do not change state.	Check supply to unit and ensure voltage selector set to correct position.

CHAPTER 6 DISPOSAL

Incorrect disposal can cause adverse effects to the environment.

Dispose of the device components and packaging material in accordance with regional environmental regulations including regulations for electrical \ electronic products.

Transducers

Remove power, disconnect the Transducer, cut off the electrical cable and dispose of cable and Transducer in accordance with regional environmental regulations for electrical \ electronic products.

Controllers

Remove power, disconnect the Controller and remove battery (if fitted). Dispose of Controller in accordance with regional environmental regulations for electrical \ electronic products.

Dispose of batteries in accordance with regional environmental regulations for batteries.



 EU WEEE Directive Logo

This symbol indicates the requirements of Directive 2012/19/EU regarding the treatment and disposal of waste from electric and electronic equipment.



www.pulsarmeasurement.com

SUPPORT@PULSARMEASUREMENT.COM

Copyright © 2020 Pulsar Measurement Ltd.

Registered Address: 1 Chamberlain Square CS, Birmingham B3 3AX

Registered No.: 3345604 England & Wales

Rev 1.0